

Front View

YP-REV150AV/GV

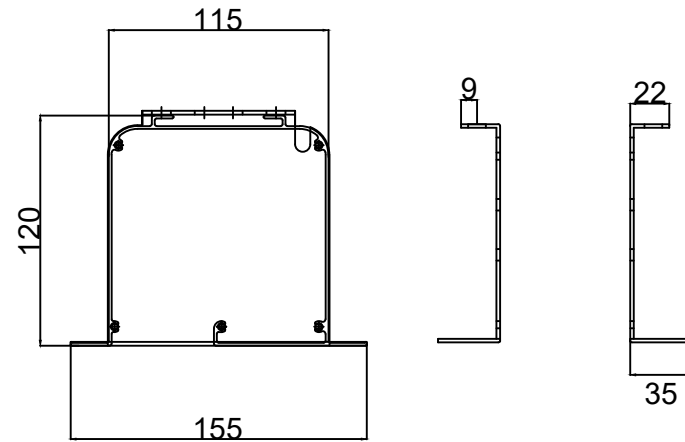

Side View